

CENTERLINE
SITE
SITE
WALL/TALL

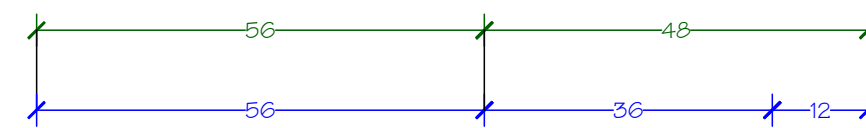

CENTERLINE
SITE
SITE
WALL/TALL

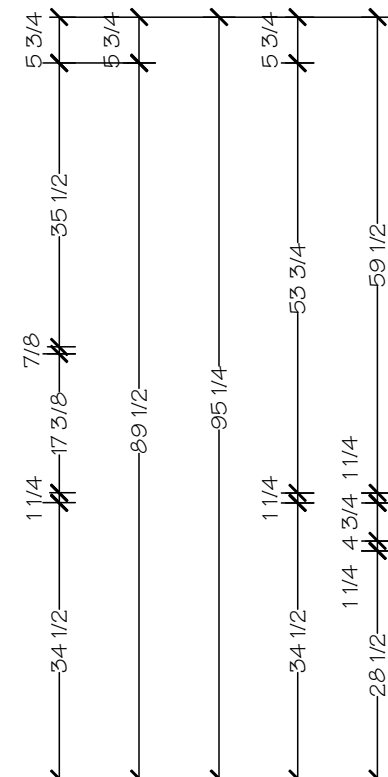
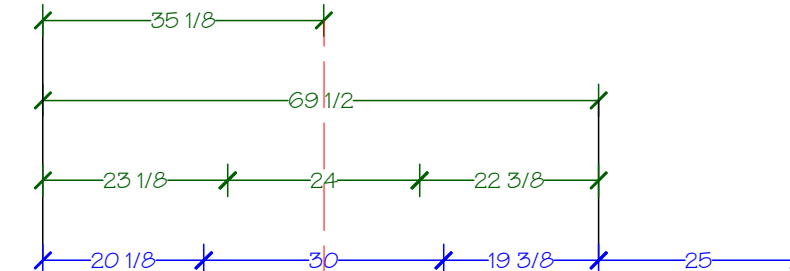

BASE/TALL

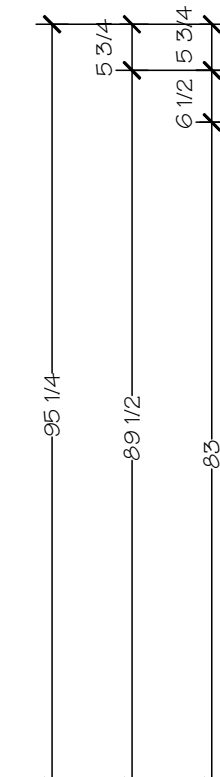
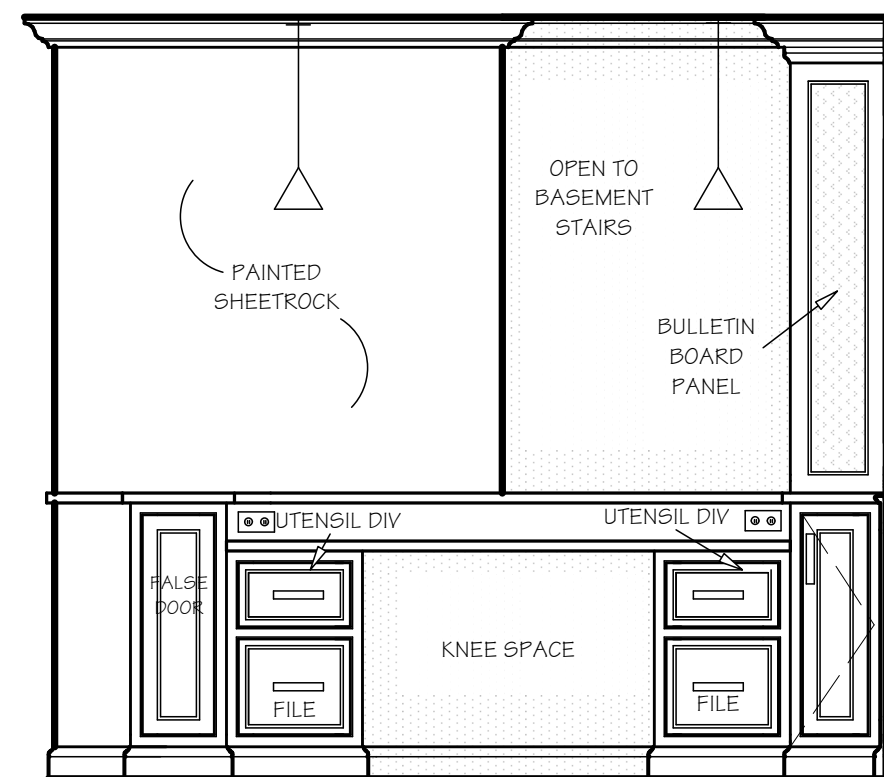

BASE/TALL

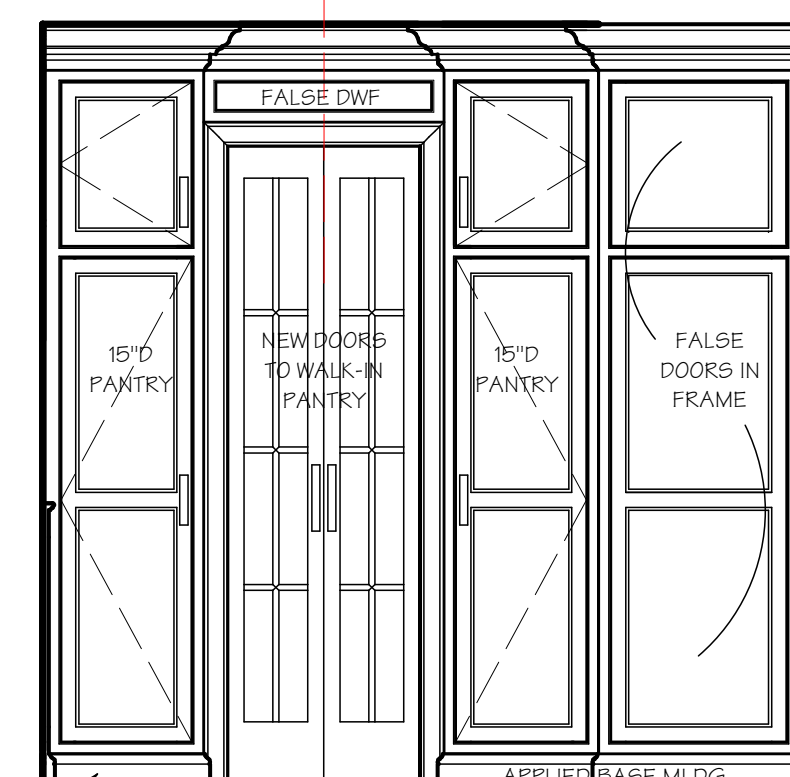

APPLIED BASE MLDG

ELEVATION A

ELEVATION B

ELEVATION C

NOTE: ADD DOOR STOP IF NECESSARY TO PREVENT DOOR FROM STRIKING MICROWAVE HANDLE

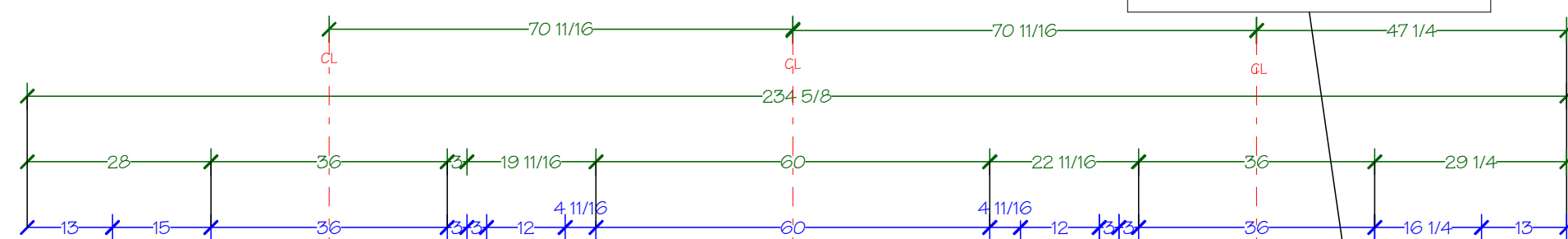

CENTERLINE
SITE
SITE
WALL/TALL

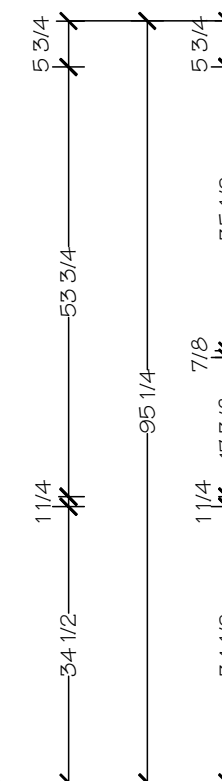
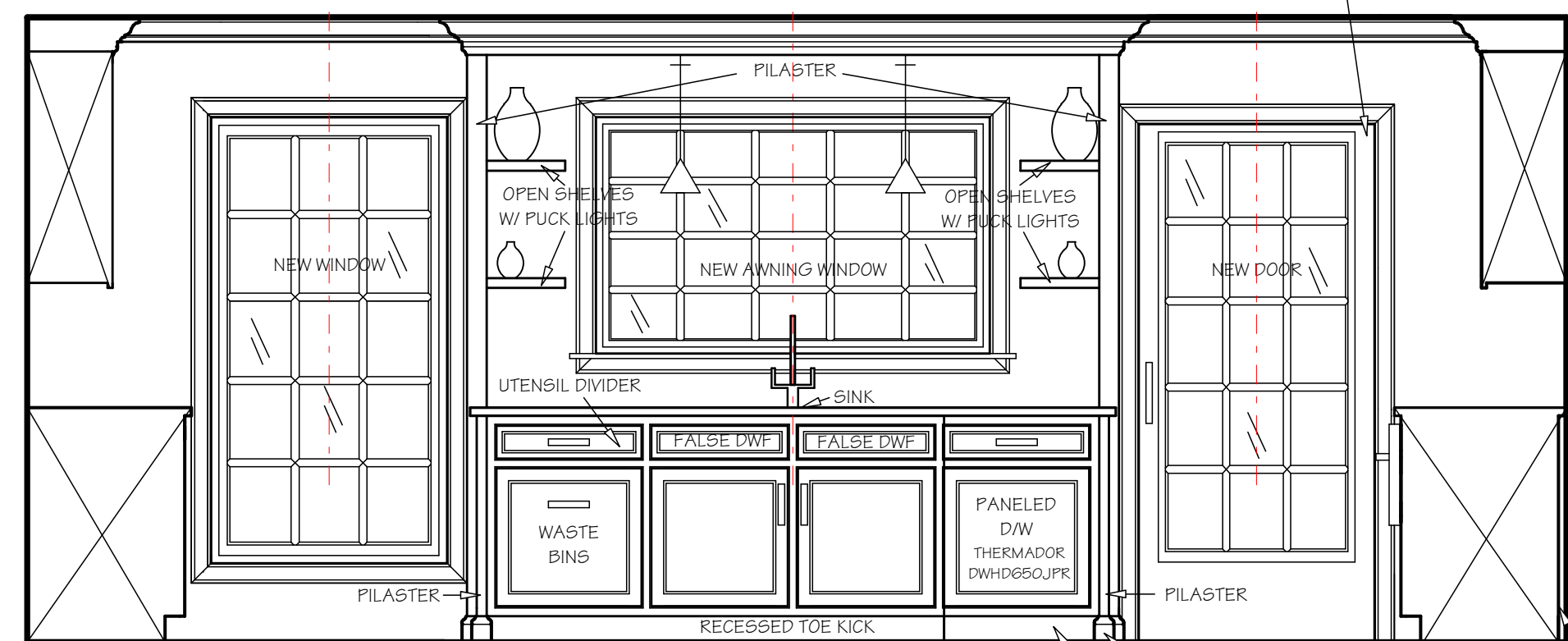

BASE/TALL

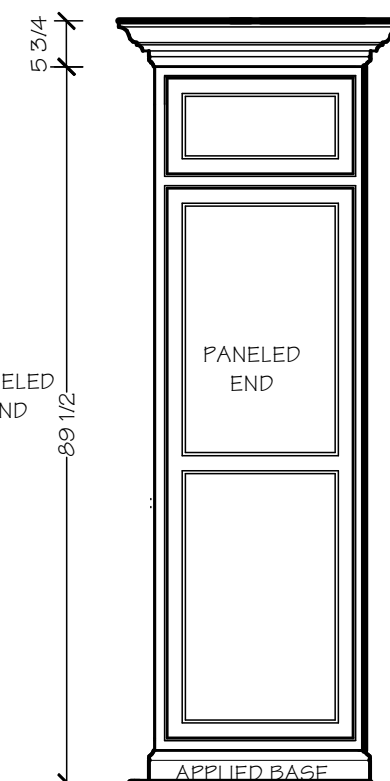
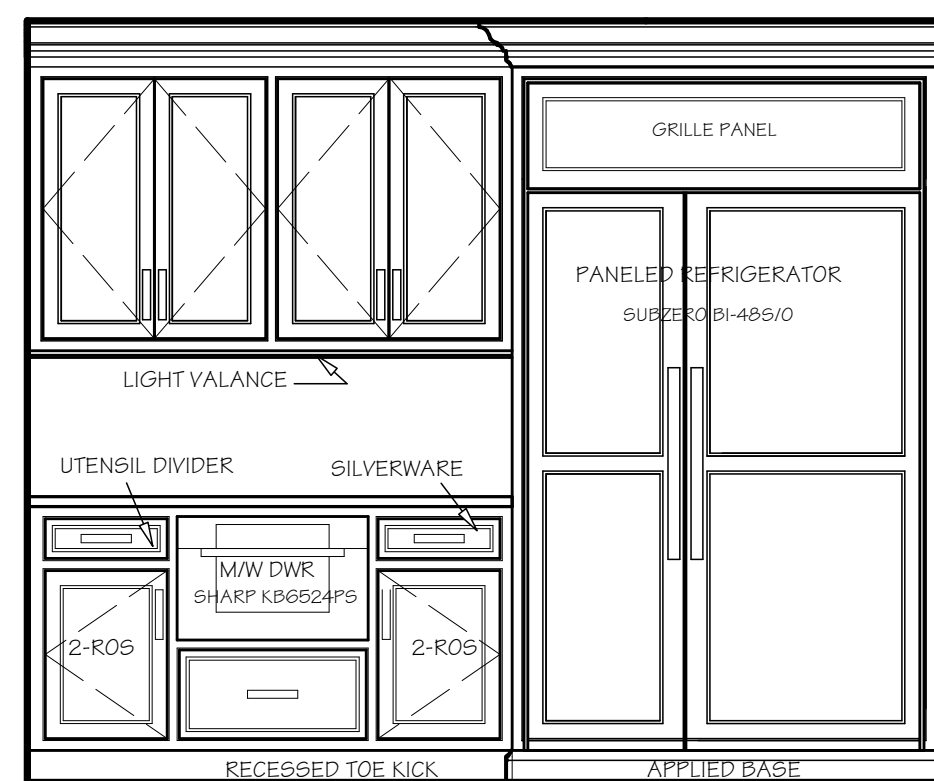

TALL

ELEVATION D

ELEVATION E

ELEVATION E - SIDE

NOTE: PULL BASE CABINETS APPROX. 1-1/4" FROM WALL TO BE 1" FROM FACE OF REFRIGERATOR CABINET



ALL DIMENSIONS AND SIZE DESIGNATIONS GIVEN ARE SUBJECT TO VERIFICATION ON JOB SITE AND ADJUSTMENT TO FIT JOB CONDITIONS

CONTRACT DOCUMENTS APPROVAL

CLIENT: DATE:
DESIGNER: DATE:



Amazing Spaces LLC
30 Fountain Road
Briarcliff Manor, NY 10510

DATE: 09-23-2013

SCALE:

SHEET:

REVISIONS:
10-3-13 10-30-13 11-1-13 11-26-13
10-28-13 10-31-13 11-5-13 12-2-13

1/2" = 1' 3 of 4

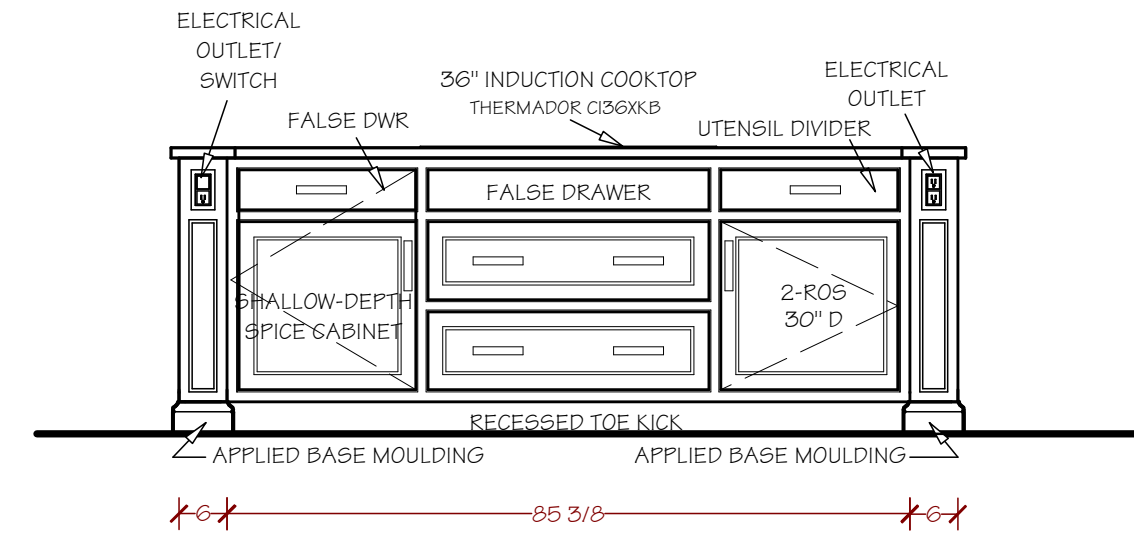
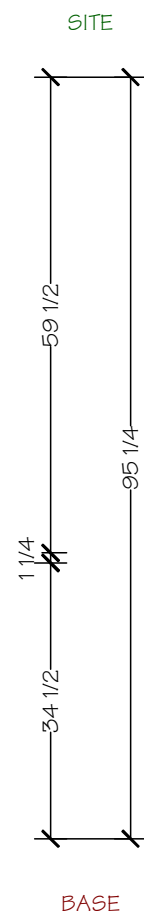
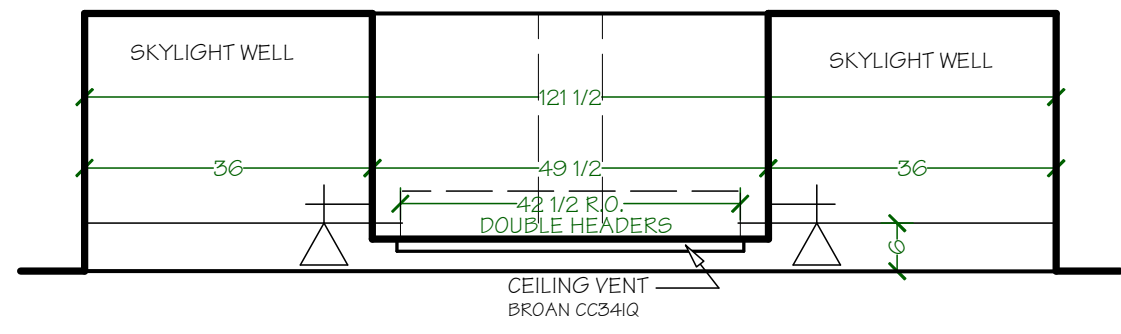

ELEVATION F

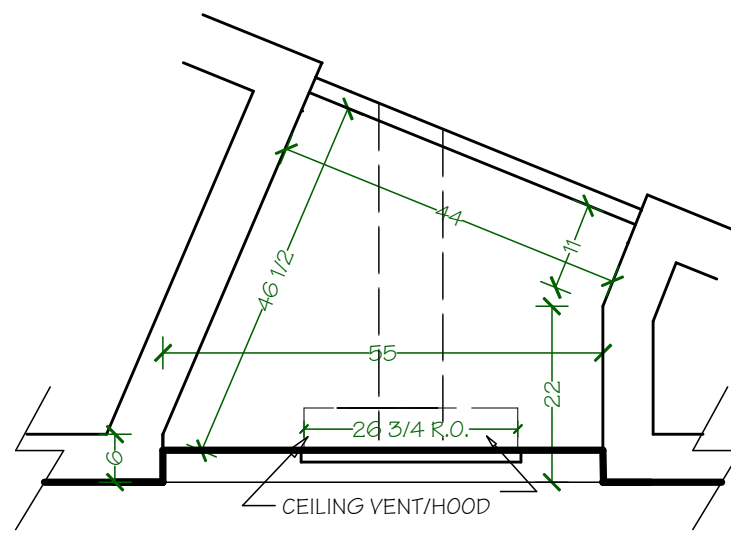

ELEVATION G

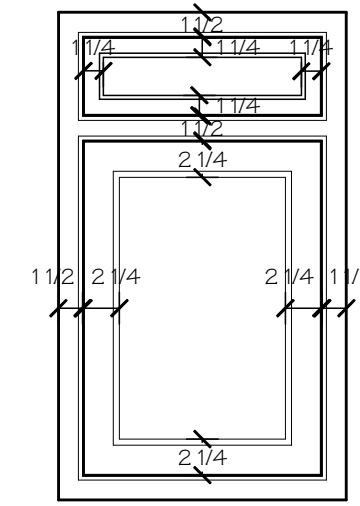

DOOR DETAIL
SCALE: 1" = 1'

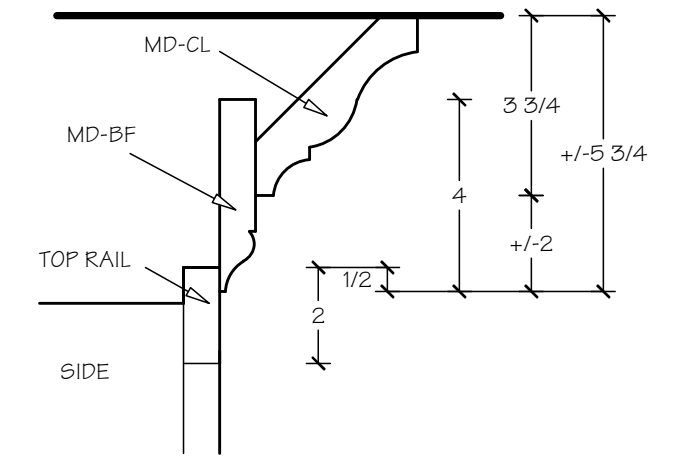

CROWN MOULDING DETAIL
SCALE: 3" = 1'

NOTE TO INSTALLER:
ATTACH 1/8" FILL AT
BOTTOM OF FRAME
FOR 1/8" OVERLAP

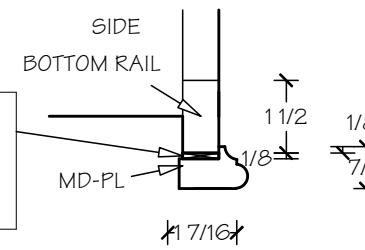

LIGHT VALANCE DETAIL
SCALE: 3" = 1'

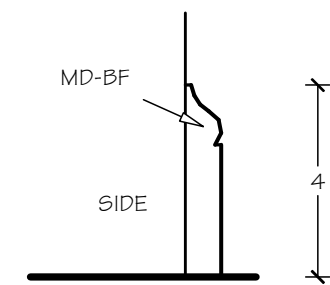

BASE MOULDING DETAIL
SCALE: 3" = 1'

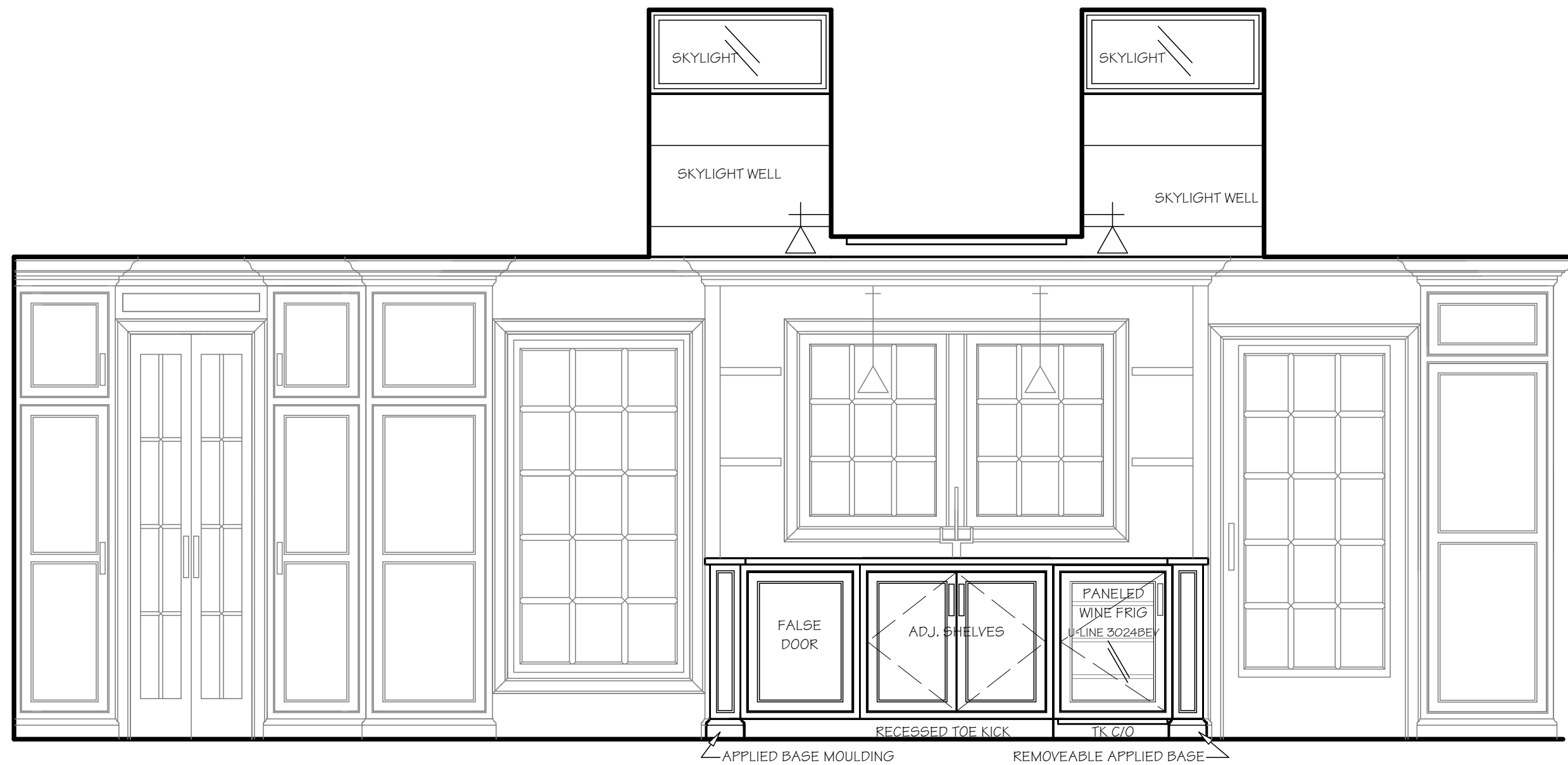

ELEVATION H

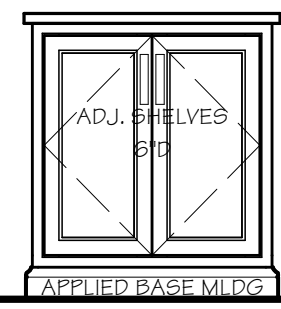
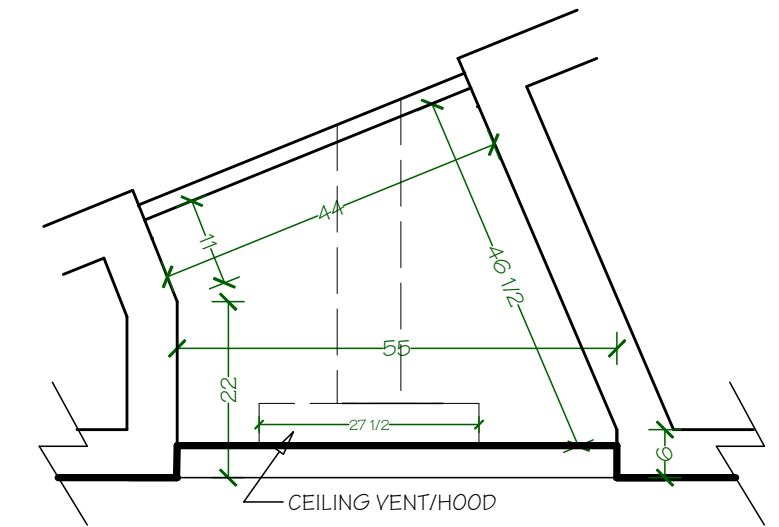

ELEVATION I



ALL DIMENSIONS AND SIZE DESIGNATIONS GIVEN ARE SUBJECT TO VERIFICATION ON JOB SITE AND ADJUSTMENT TO FIT JOB CONDITIONS

CONTRACT DOCUMENTS APPROVAL

CLIENT: DATE:
DESIGNER: DATE:



Amazing Spaces LLC
30 Fountain Road
Briarcliff Manor, NY 10510

DATE: 09-23-2013

SCALE:

SHEET:

REVISIONS:

10-3-13 10-30-13 11-1-13 11-26-13
10-28-13 10-31-13 11-5-13 12-2-13

1/2" = 1'

4 of 4